

SIRUBA®

銀爺牌工業用縫紉機

INDUSTRIAL SEWING MACHINE









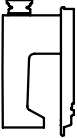

L918



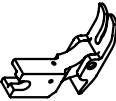





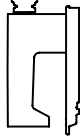

WITH TRIMMER

零件圖 PARÇA LİSTESİ

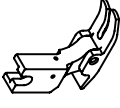

高林股份有限公司
KAULIN MFG. CO., LTD.

										
MODEL	SUB-CLASS	OPERATING PANEL	NEEDLE PLATE	FEED DOG	PRESSER FOOT	HOOK ASM	BOBBIN CASE ASM	BOBBIN	NEEDLE	HAND WHEEL
機 型	規 格	操 作 盒	針 板	送 具	押 具	梭 頭	梭 殼	梭 子	針 號	皮 帶 輪
L 918-L1-00 ~ L 918-L1-03	薄布料	無	E701	D701	P721	G121	G202	G303	DA*1#9	LH01-A1
L 918-L1-10 ~ L 918-L1-13		L-900	E701	D701	P721	G121	G202	G303	DA*1#9	
L 918-M1-00 ~ L 918-M1-03	薄中布 至 厚布料	無	E704	D701	P701	G121	G202	G303	DB*1#14	
L 918-M1A-00 ? (L 918-M1C-00) L 918-M1A-03 ? (L 918-M1C-03)			E704D	D702	P701	G121	G202	G303	DB*1#14	
L 918-M1-10 ~ L 918-M1-13		L-900	E704	D701	P701	G121	G202	G303	DB*1#14	
L 918-M1A-10 ? (L 918-M1C-10) L 918-M1A-13 ? (L 918-M1C-13)			E704D	D702	P701	G121	G202	G303	DB*1#14	

										
MODEL	SUB-CLASS	OPERATING PANEL	NEEDLE PLATE	FEED DOG	PRESSER FOOT	HOOK ASM	BOBBIN CASE ASM	BOBBIN	NEEDLE	HAND WHEEL
機 型	規 格	操作盒	針 板	送 具	押 具	梭 頭	梭 殼	梭 子	針 號	皮 帶 輪
L918-H1-00 ┆ L918-H1-03			E711	D711	P711	G125	G202	G303	DB*1#21	GLH01-A1
L918-H1-00A ┆ L918-H1-03A	中厚布	無	E711	D711	P711	G125	G202	G303	DB*1#21	GLH01Q-E
L918-H1A-00 ┆ L918-H1A-03	至		E711D	D711D	P711D	G125	G202	G303	DB*1#21	GLH01-A1
L918-H1A-00A ┆ L918-H1A-03A	厚布料		E711D	D711D	P711D	G125	G202	G303	DB*1#21	GLH01Q-E
L918-H1-10 ┆ L918-H1-13		L-900	E711	D711	P711	G125	G202	G303	DB*1#21	GLH01-A1
L918-H1A-10 ┆ L918-H1A-13		L-900	E711D	D711D	P711D	G125	G202	G303	DB*1#21	GLH01-A1

型別件對照表 MODEL KARŞILAŞTIRMA LİSTESİ

H1

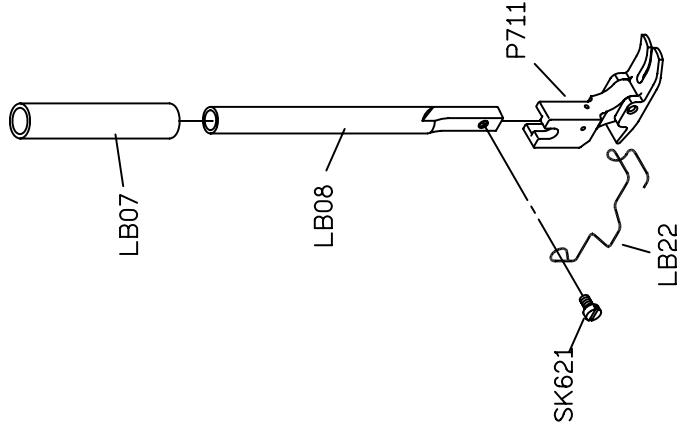

H1R

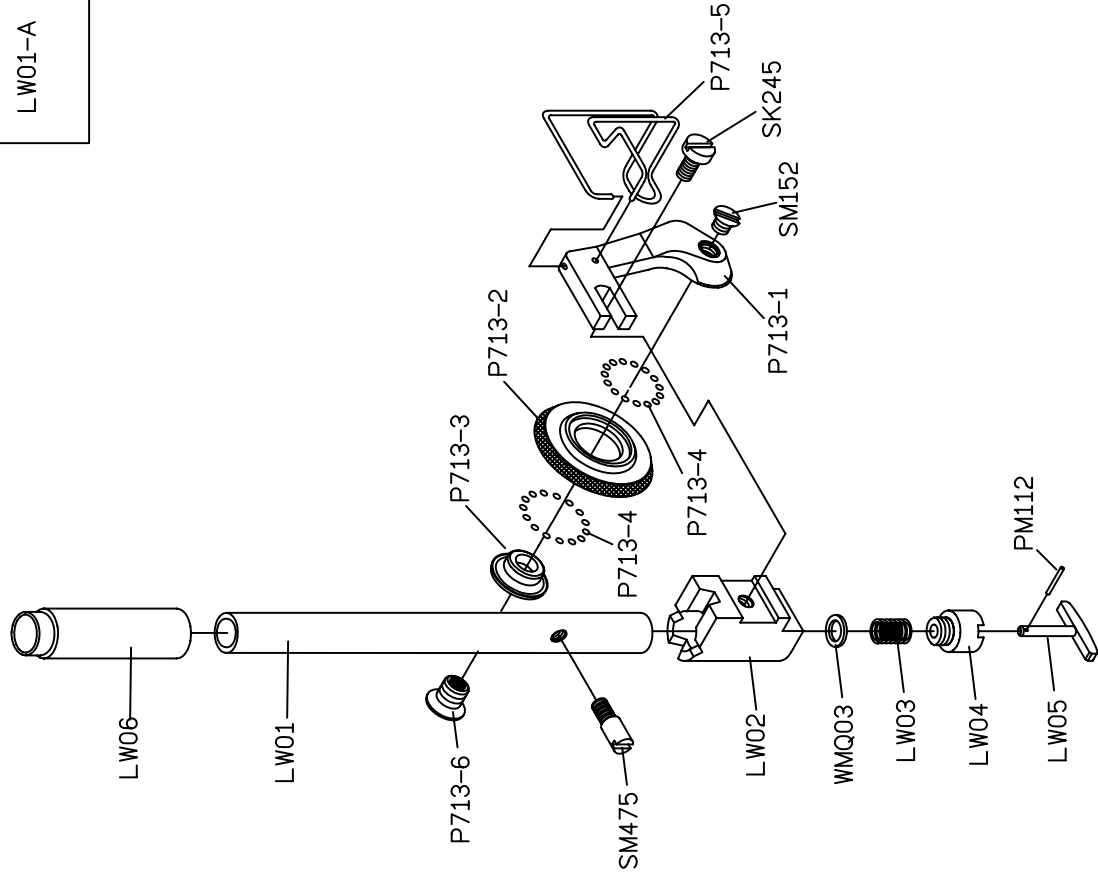

MODEL	SUB-CLASS	SPRING	SPRING	SPRING	SPRING	THREAD GUIDE	THREAD GUIDE	SPRING	THREAD GUIDE	THREAD GUIDE	THREAD GUIDE BAR	EJECTOR PIN	ADJUSTING KNOB
機 型	規 格	控線彈簧	控線彈簧	挑線彈簧	固定片	擋環片	壓簧	導線片	導線桿	頂出銷	調整旋鈕		
L918 /L1	薄布料	LA231	LA22	LA227	—	A LA17 B SK613	LB204	A LB06 B SK241	—	LB12	LC23G LC801		
		LA31D	LA22	LA27	A LA617 B SK690 C LU38	—	LB04	A LB06 B SK241	—	LB12	LC623G		
L918 /H1	中厚料 ~ 厚布料	LA131	LA122	LA27	A LA600 B SK690 C LU38	—	LB104	—	A LB100 B GLB106 C NK23 D WK09	LB12	LC600G		

型別件對照表 MODEL KARŞILAŞTIRMA LİSTESİ

型別件對照表 MODEL KARŞILAŞTIRMA LİSTESİ

MODEL	SUB-CLASS	REGULATOR	CONNECTING ROD SENT	FIXED PIN	HOOK FIXER	COVER	THRAD TAKE UP LEVER	CRANK SHAFT	BUSING	THREAD GUIDE
機 型	規 格	調整銷	連桿座	固定銷	旋梭定位板	護蓋	天秤	曲軸	襯套	導線環片
L918 /L1	薄布料	LH11	LC12	LC13	LE14	A LG01 B SK219	LG13	LG215	LG07	LG09
L918 /M1	薄布料	LH11	LC12	LC13	LE14	A LG01 B SK219	LG13	LG15	LG07	LG09
L918 /HM1	中厚料	LH111	LC612	LC613	LE614	A LG101 B SK501	LG113	LG615	LG107	LG109
L918 /H1	中厚料 ~ 厚布料	LH111	LC612	LC613	LE614	A LG101 B SK501	LG113	LG615	LG107	LG109

MODEL	SUB-CLASS	NEEDLE BAR	SPRING	ECCENTRIC	SOLENOID BRACKET	PRESSER PLATE	FIXED PLATE	FIXED PLATE	CONNECTING ROD	CONNECTING ROD
機 型	規 格	針 棒	拉 伸 彈 簧	偏 心 凸 輪	電 磁 閥 座	押 板	固 定 刀	固 定 片	連 桿	連 桿
L918 /L1	薄布料	LG04	LC10	LH06	LU26	LU04	LU05	LU28	A LU15 B SK662 C EM050 D SK664	—
L918 /M1	薄布料 ~ 中厚料	LG04	LC10	LH06	LU26	LU04	LU05	LU28	A LU15 B SK662 C EM050 D SK664	—
L918 /HM1	中厚料	LG104H	LC10	LH606	LU626	LU604	LU605	LU628	A LU615 B SK677 C NK26/MM402 D SK682	—
L918 /H1	中厚料 ~ 厚布料	LG104	LC10	LH606	LU626	LU604	LU605	LU628	A LU615 B SK677 C NK26/MM402 D SK682	—

型別件對照表 MODEL KARŞILAŞTIRMA LİSTESİ

MODEL 機 型	SUB-CLASS 規 格	MOVABLE KNIFE 活動刀	MOVABLE KNIFE 活動刀	MOVABLE KNIFE 活動刀	MOVABLE KNIFE 活動刀連接桿	MOVABLE KNIFE 活動刀連接桿	PRESSER PLATE 刀座	MOVABLE KNIFE 轉子連接	TRIMMER SOLENOID 切線電磁閥
L918 /L1	薄布料	A LU02	—	—	LU01	—	LU03	LU18	LU25
		B SK660							
L918 /M1	薄布料 ~ 中厚料	A LU02	—	—	LU01	—	LU03	LU18	LU25
		B SK660							
L918 /HM1	中厚料 ~ 厚布料	—		A LU602	—	—	LU603	LU618	LU625
		—		B SK683					
L918 /H1	中厚料 ~ 厚布料	—		A LU602	—	—	LU603	LU618	LU625
		—		B SK683					

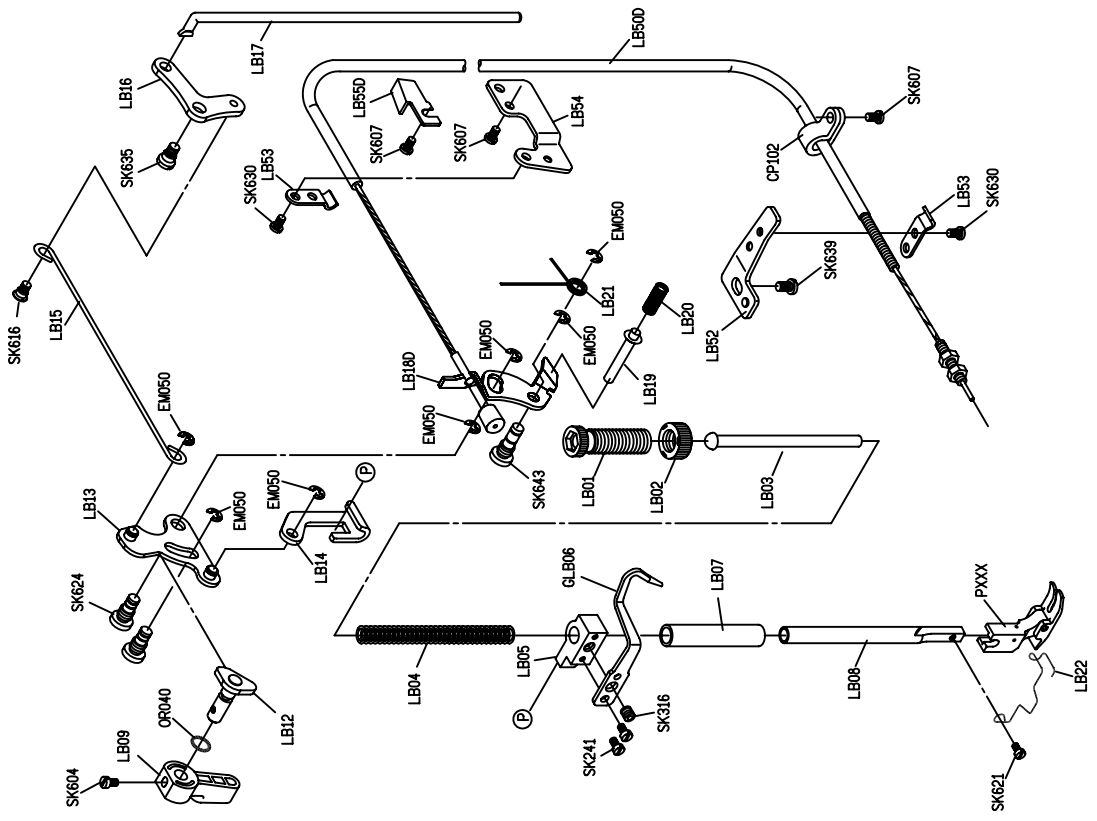

LB GRUP İÇİN PARÇA LİSTESİ

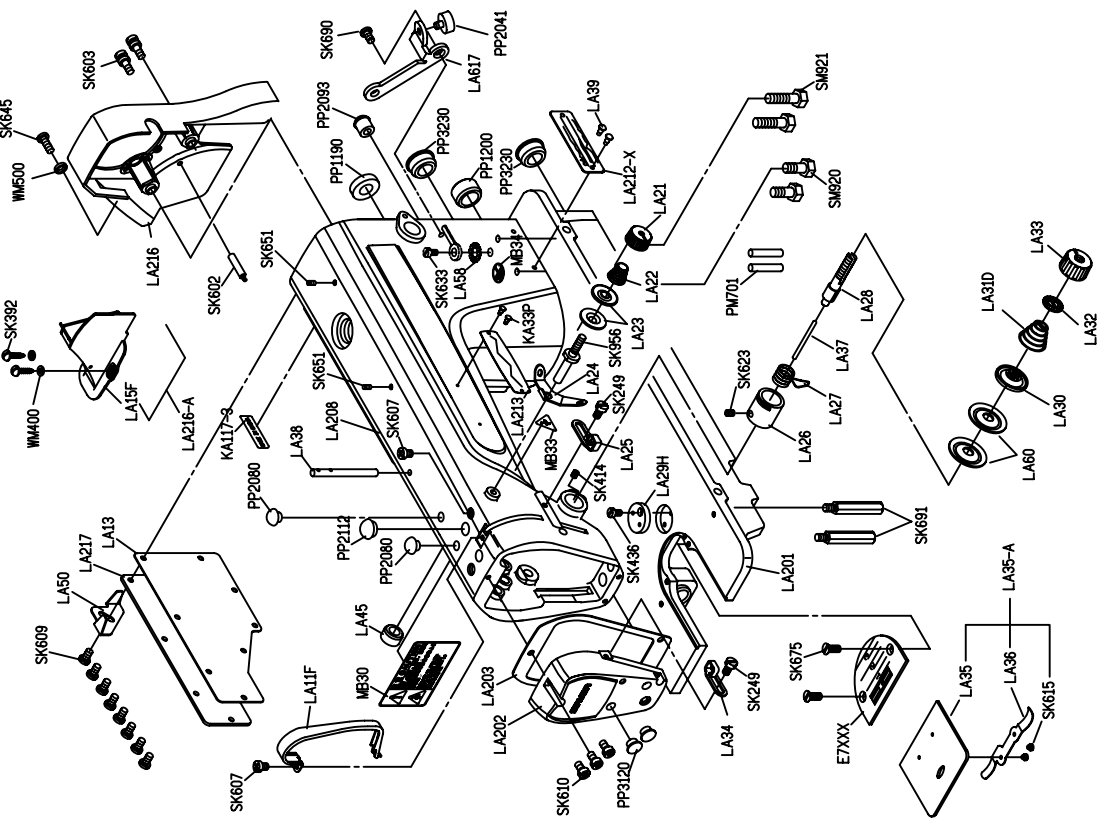

LA GRUP İÇİN PARÇA LİSTESİ

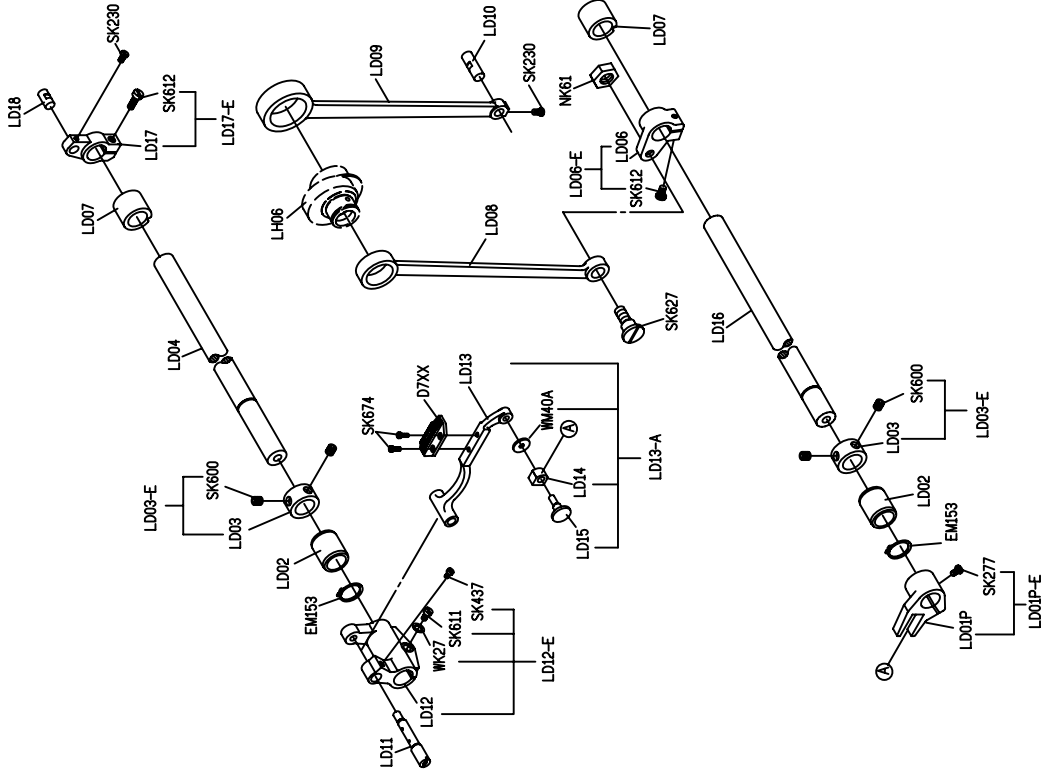
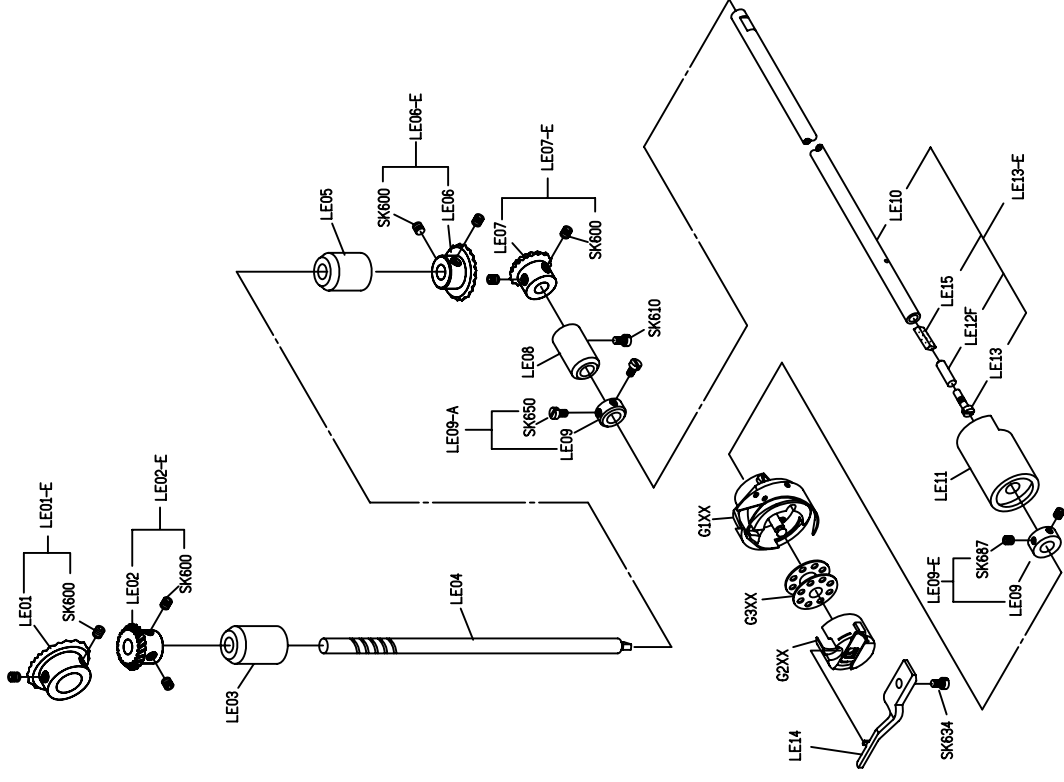

LD GRUP İÇİN PARÇA LİSTESİ

LE GRUP İÇİN PARÇA LİSTESİ

LG GRUP İÇİN PARÇA LİSTESİ

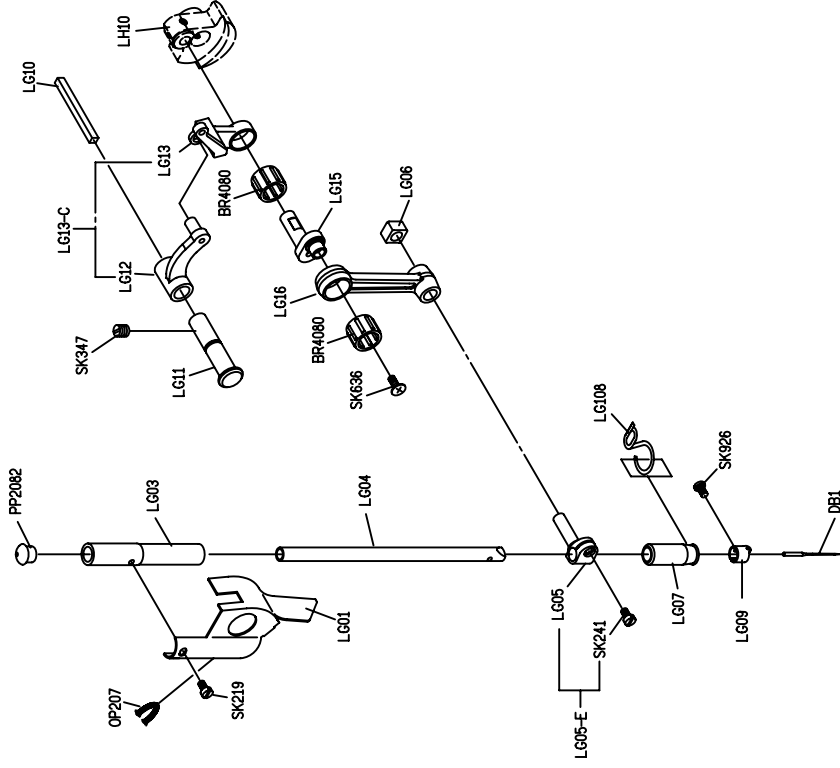

LH GRUP İÇİN PARÇA LİSTESİ

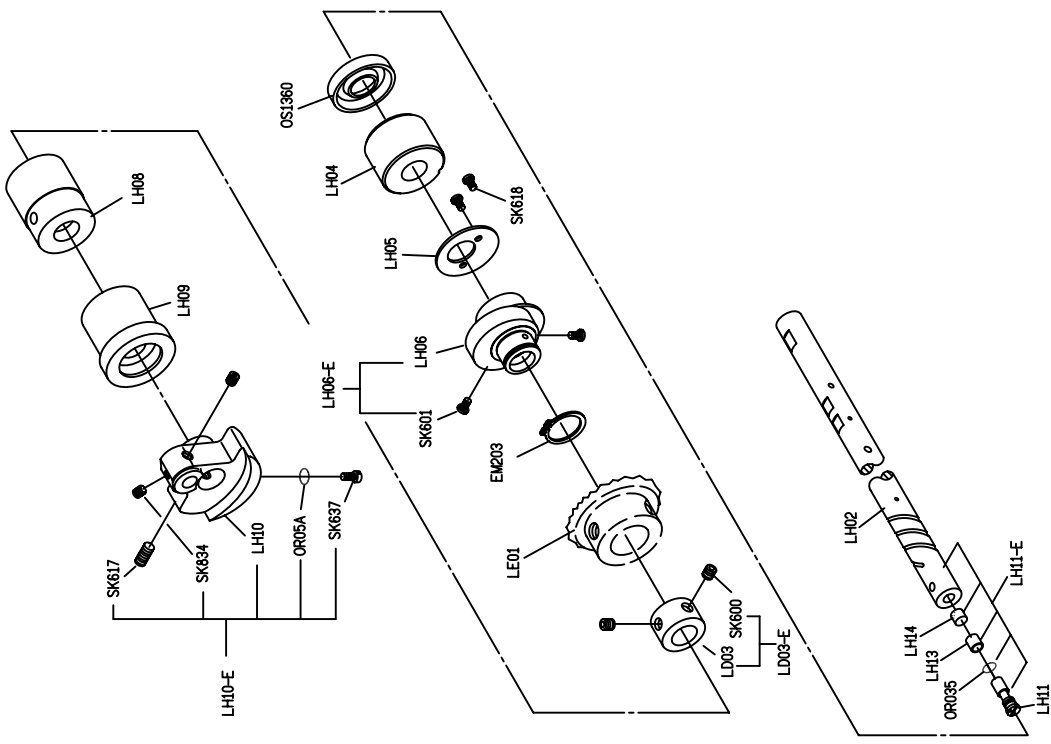

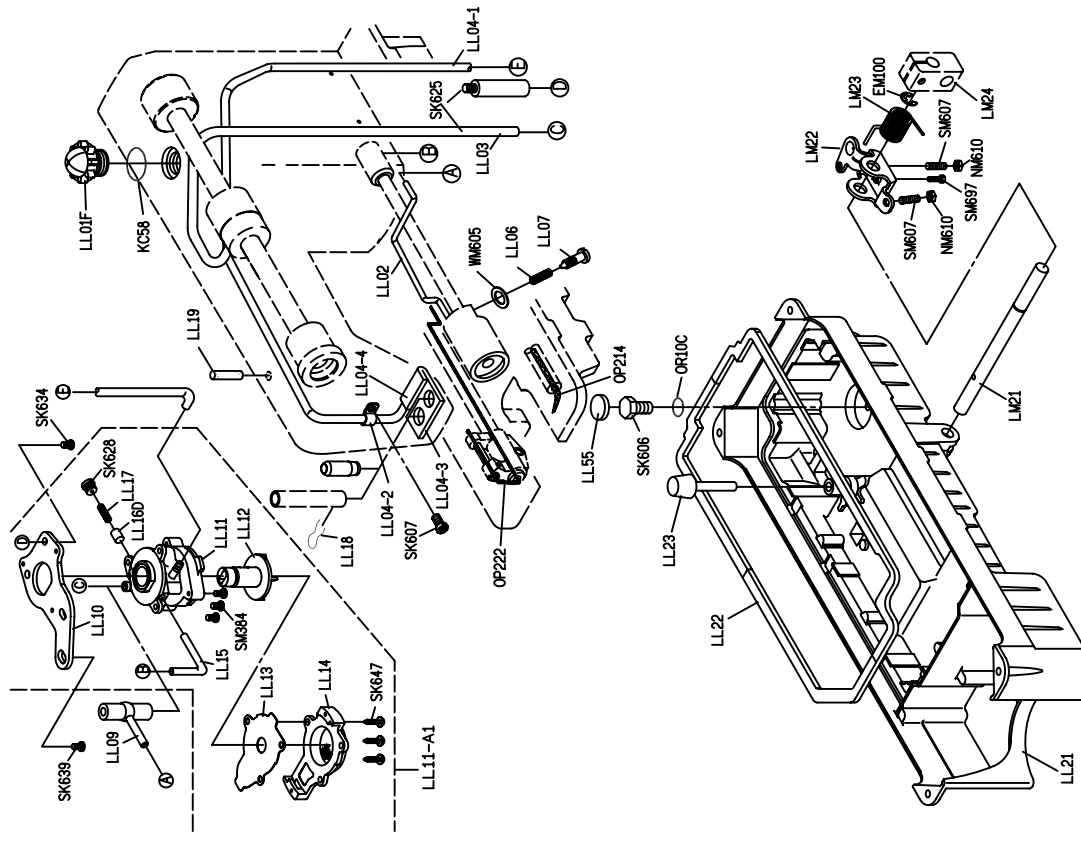
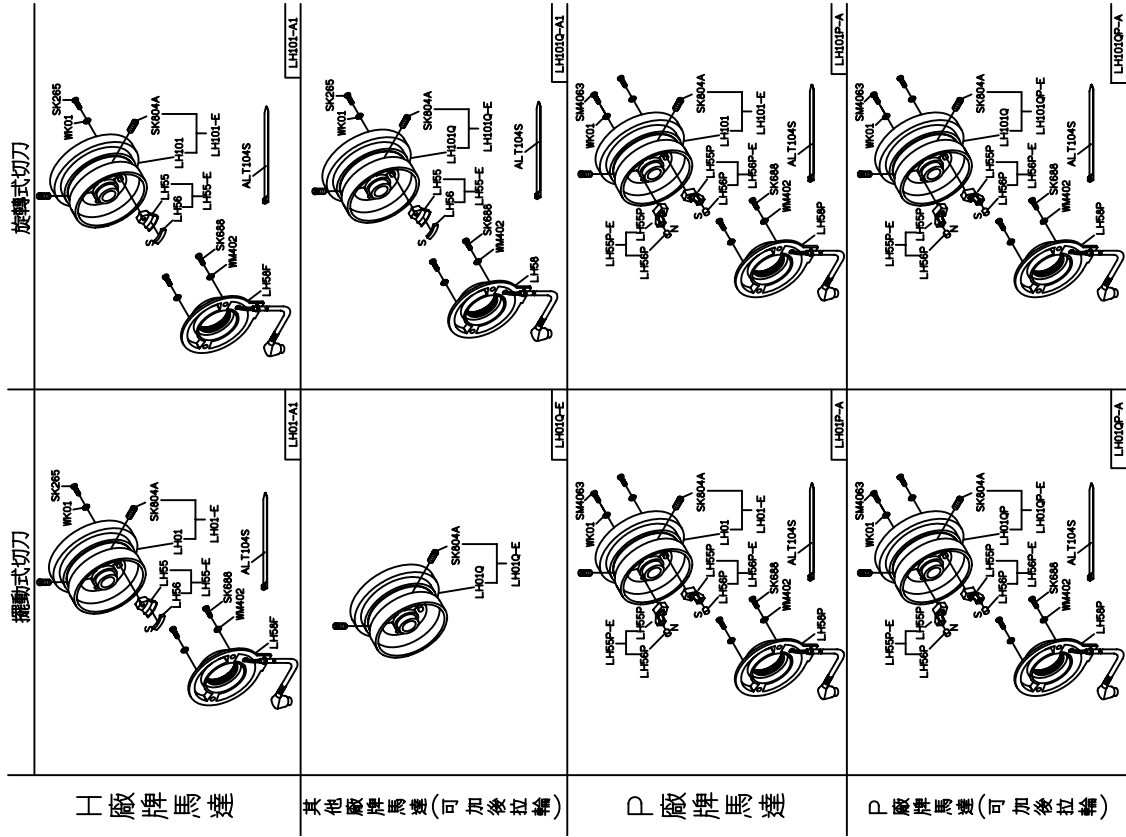

LH GRUP İÇİN PARÇA LİSTESİ

LL GRUP İÇİN PARÇA LİSTESİ

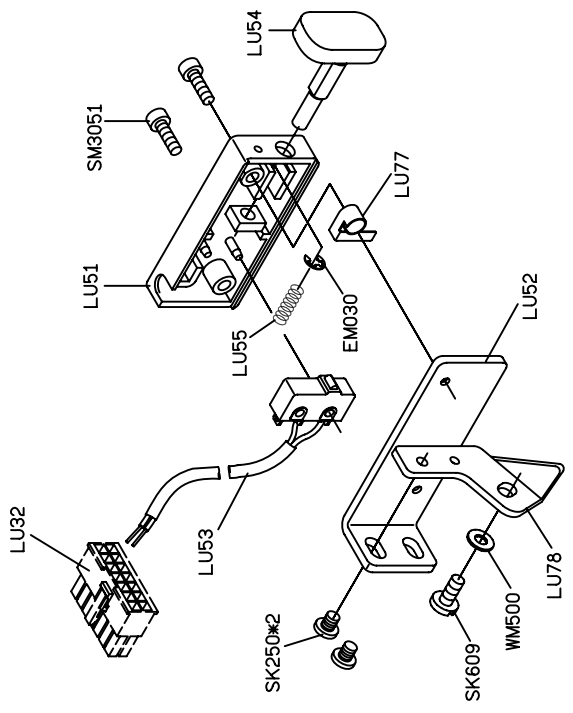
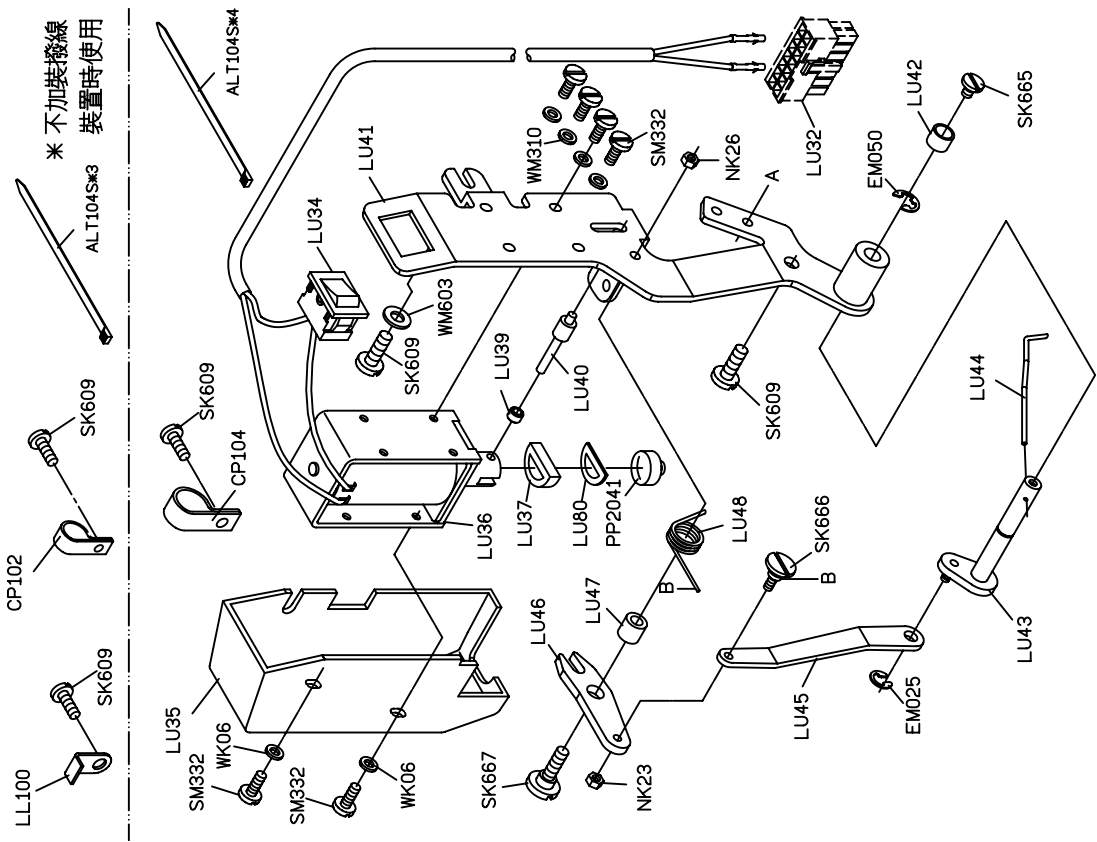

LU GRUP İÇİN PARÇA LİSTESİ

LU GRUP İÇİN PARÇA LİSTESİ

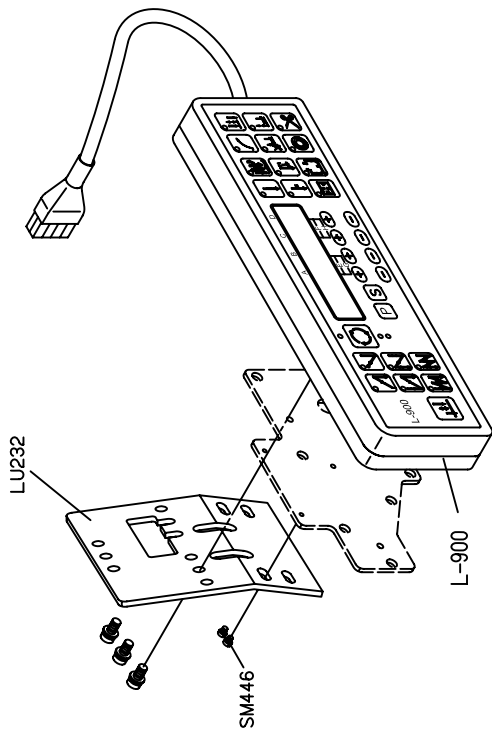
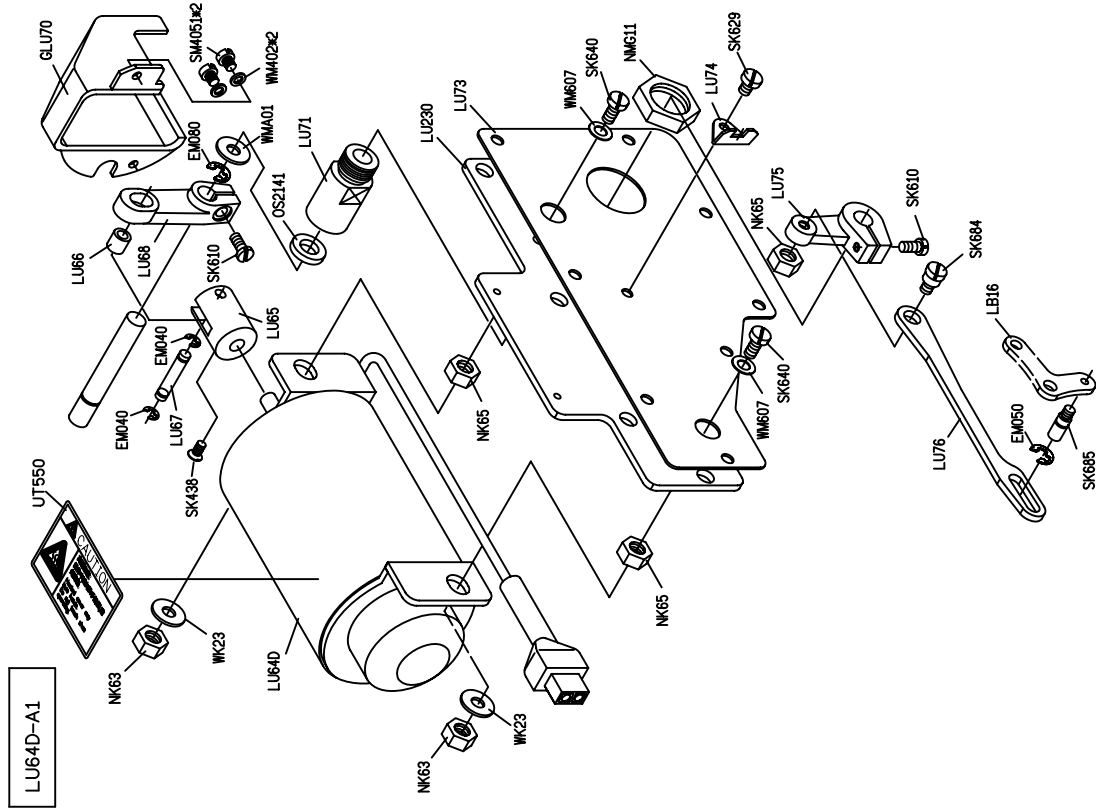

註：此部份置於配件箱內

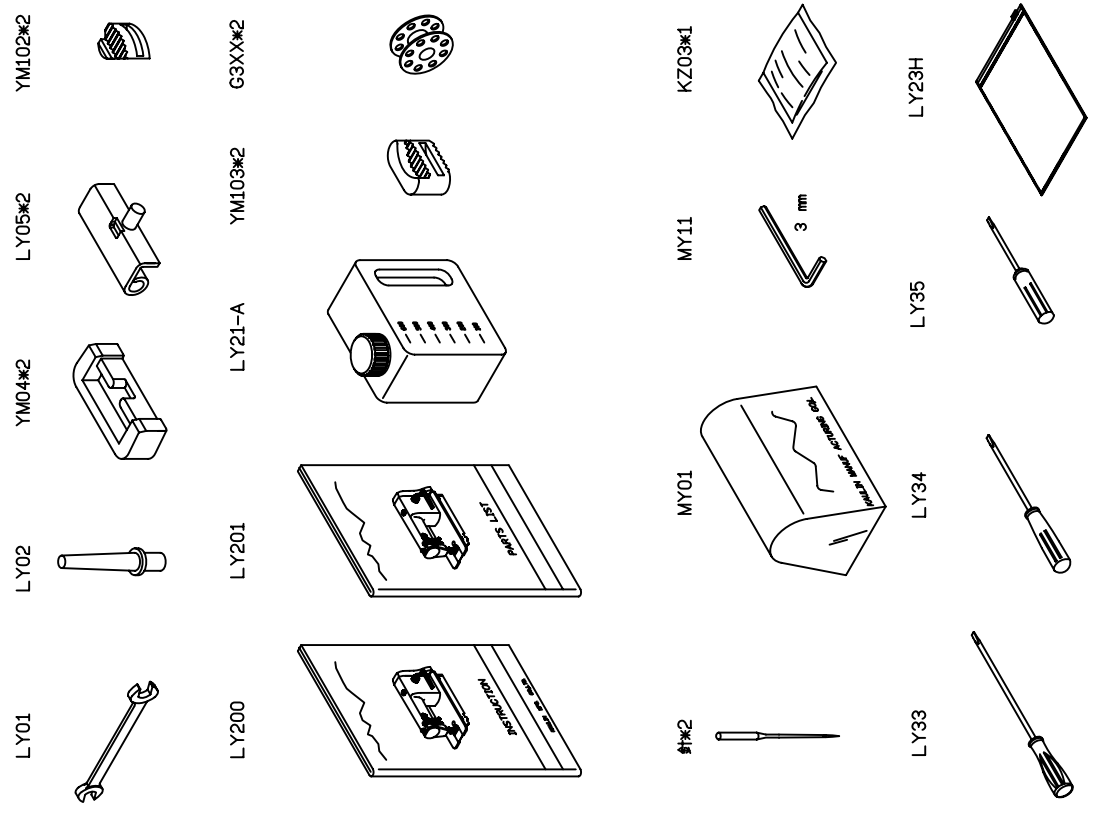
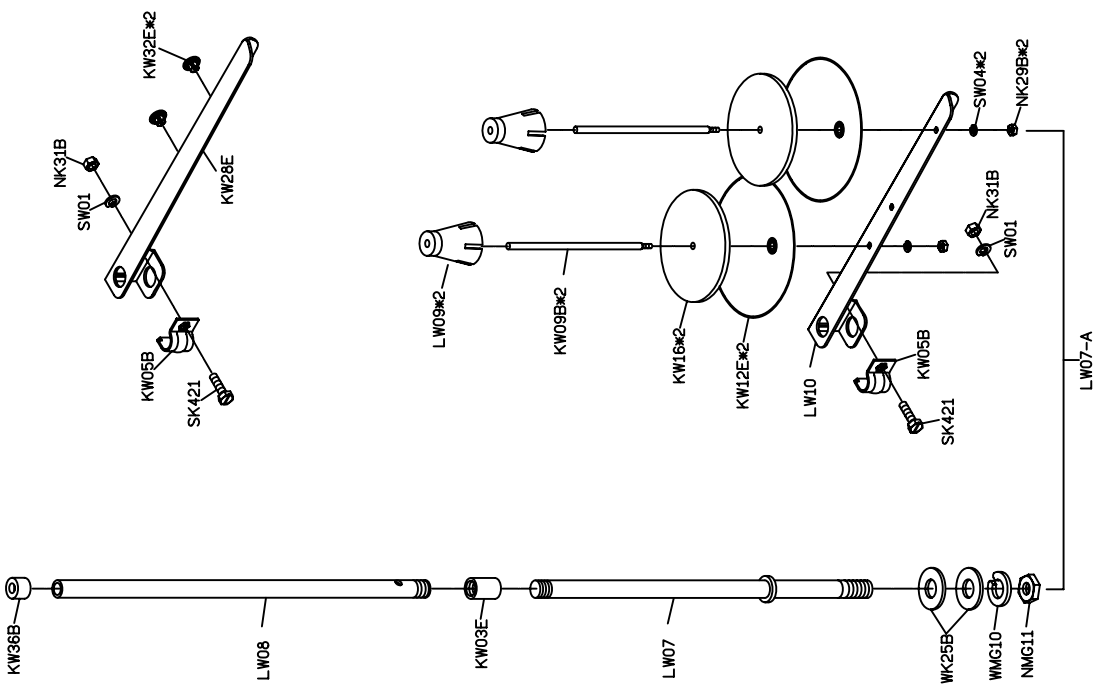

LY GRUP İÇİN PARÇA LİSTESİ

THREAD STAND GRUP İÇİN PARÇA LİSTESİ

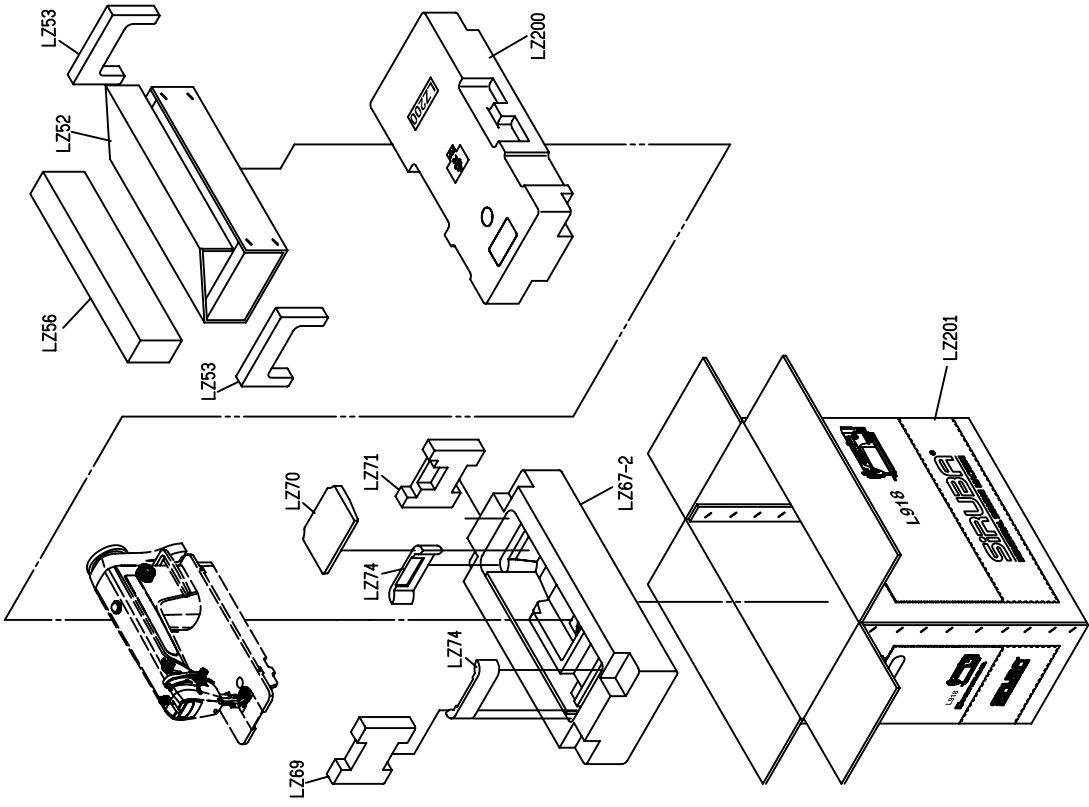



L918

WITH TRIMMER

高林股份有限公司 KAULIN MFG. CO., LTD.